

Installation

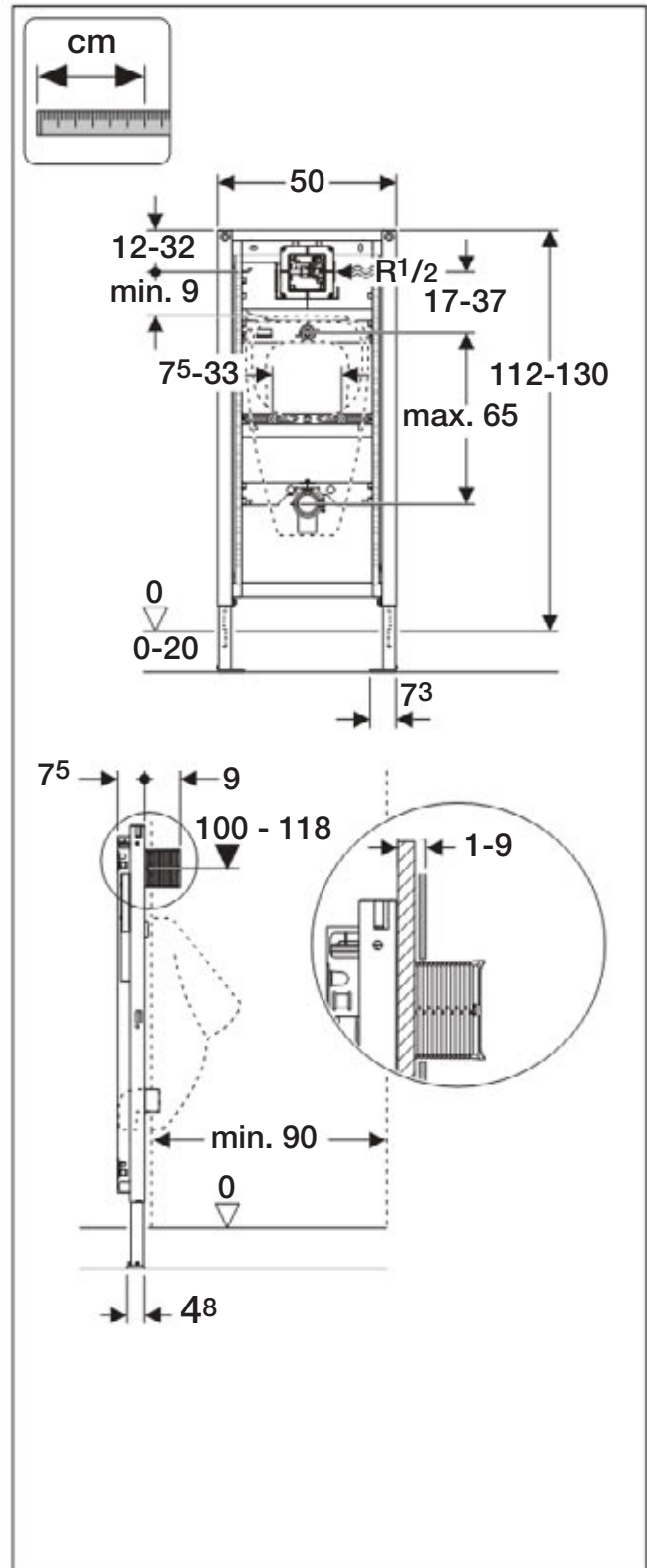

D19932-001&BDC © 07-2008

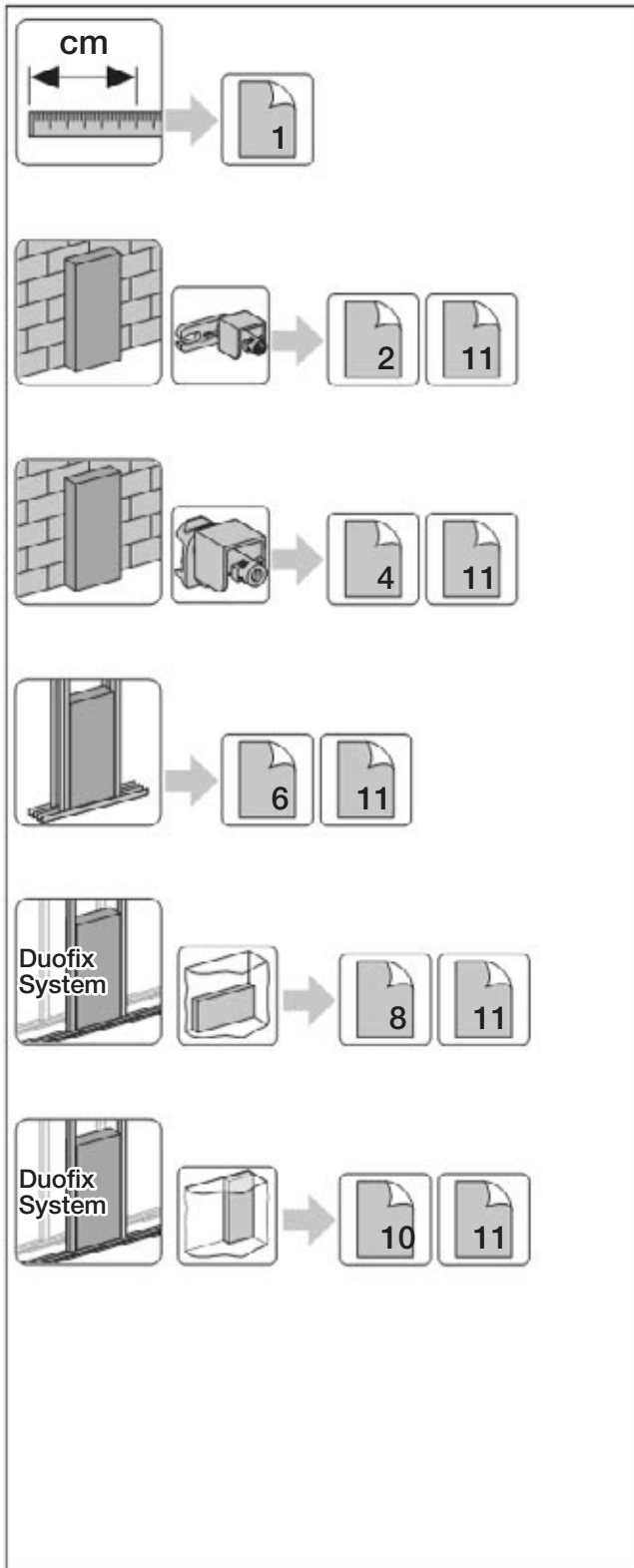

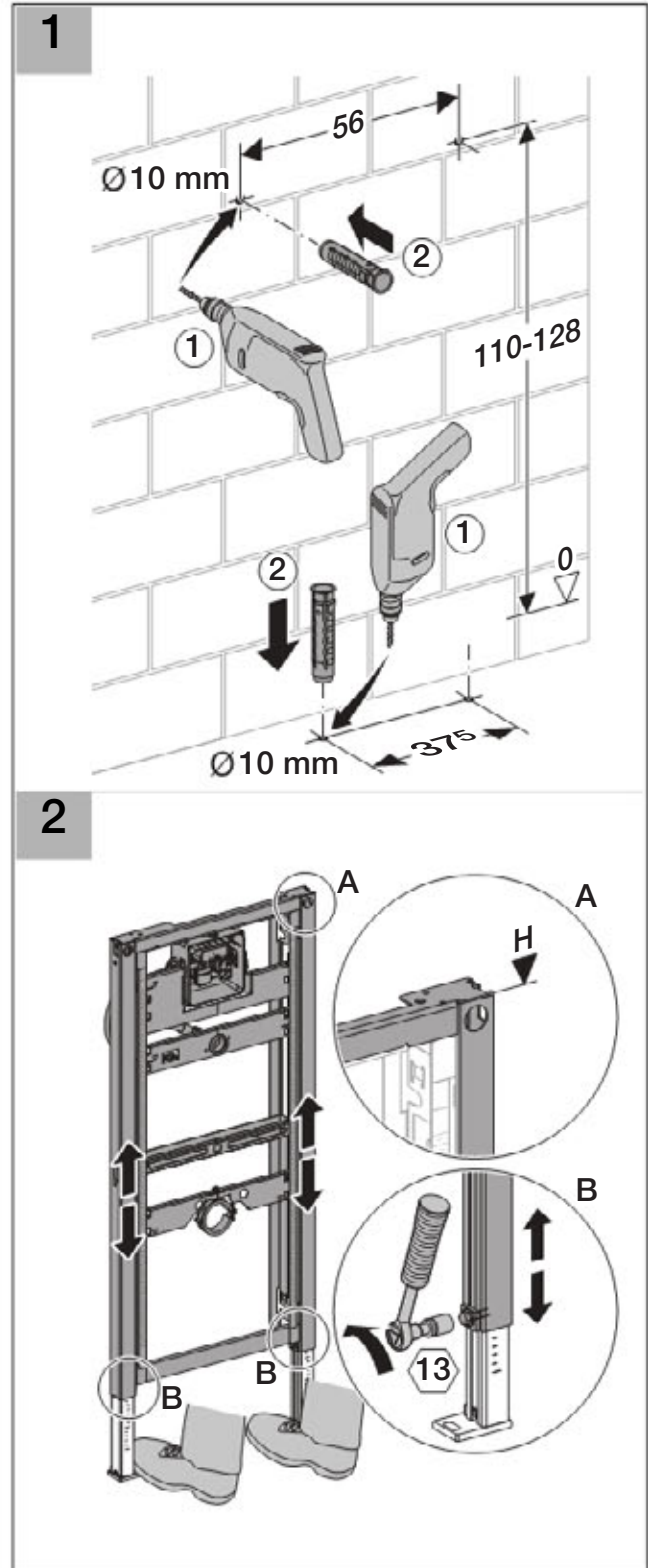
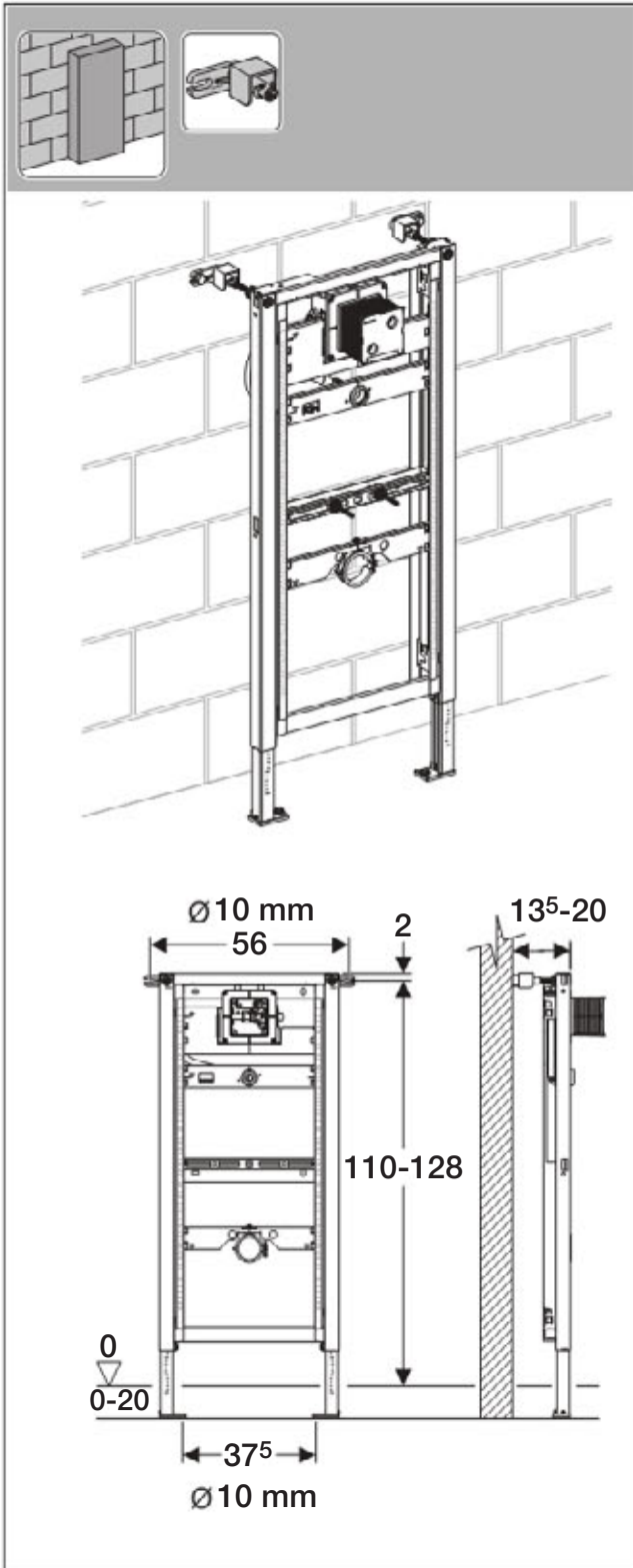
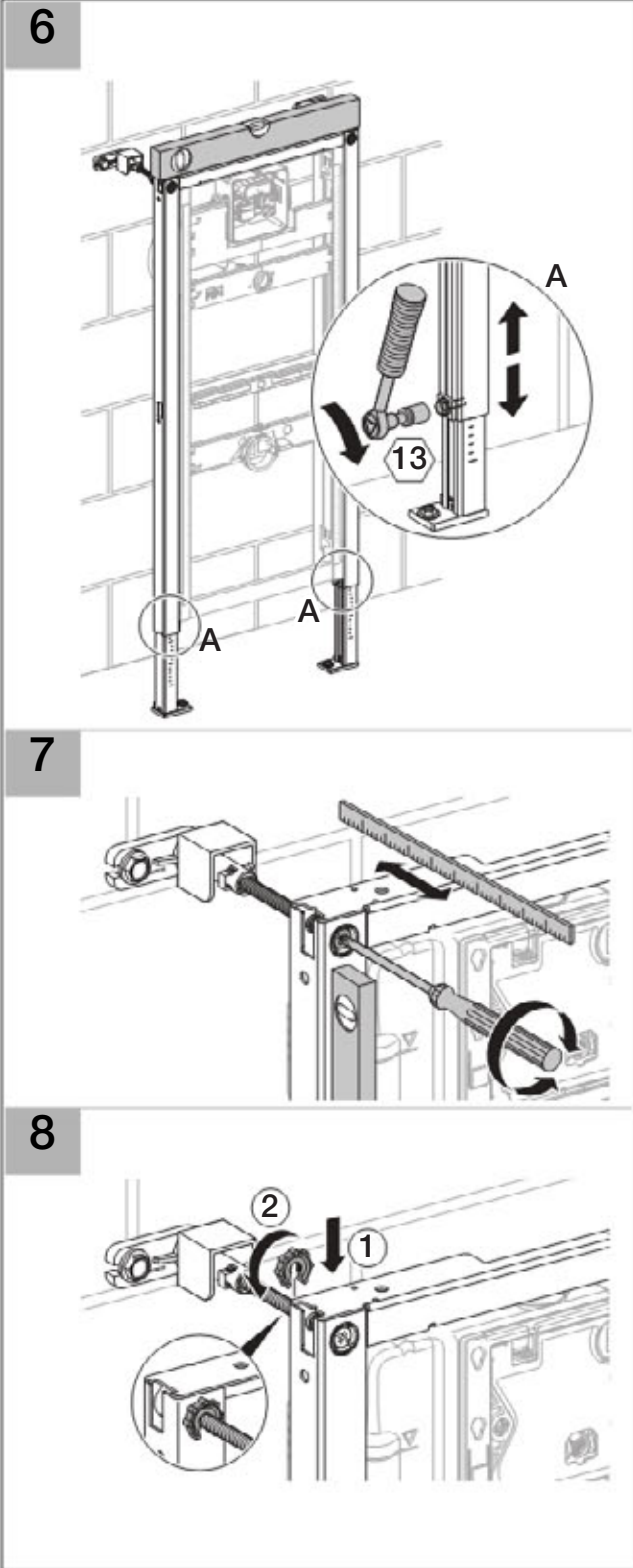
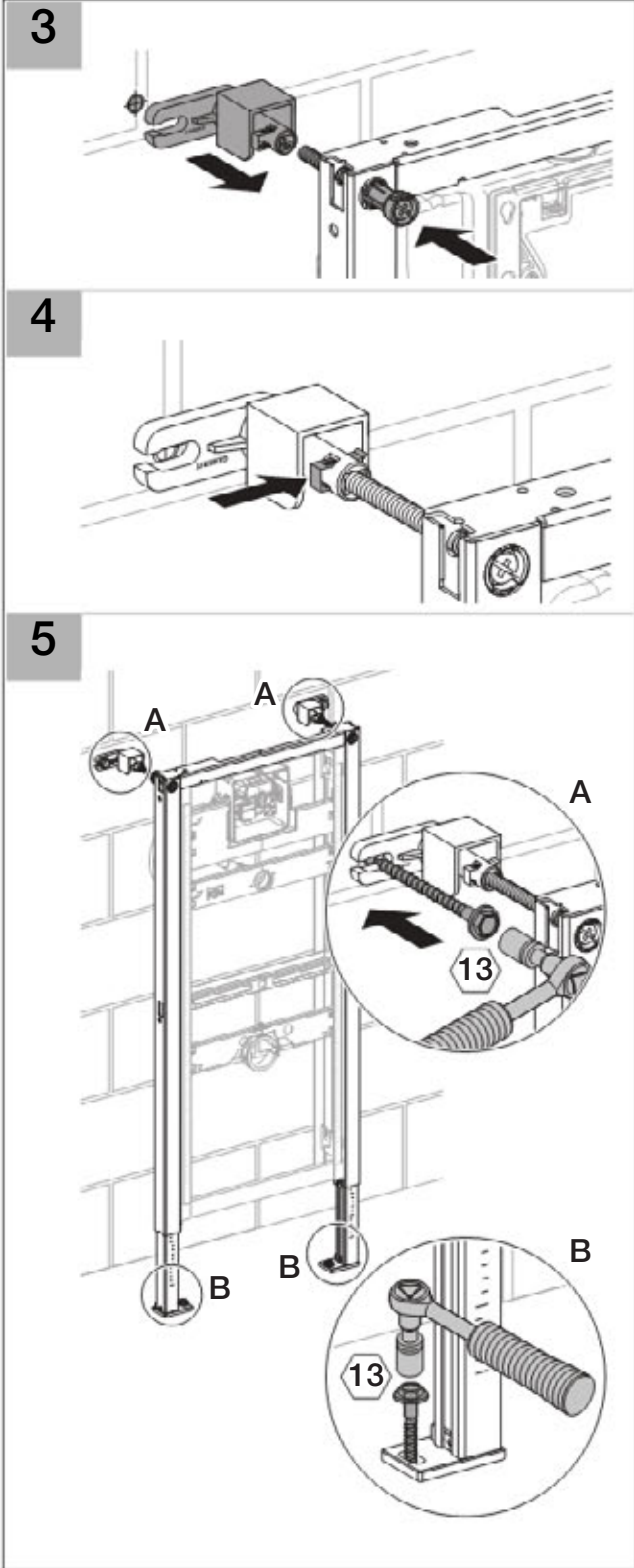

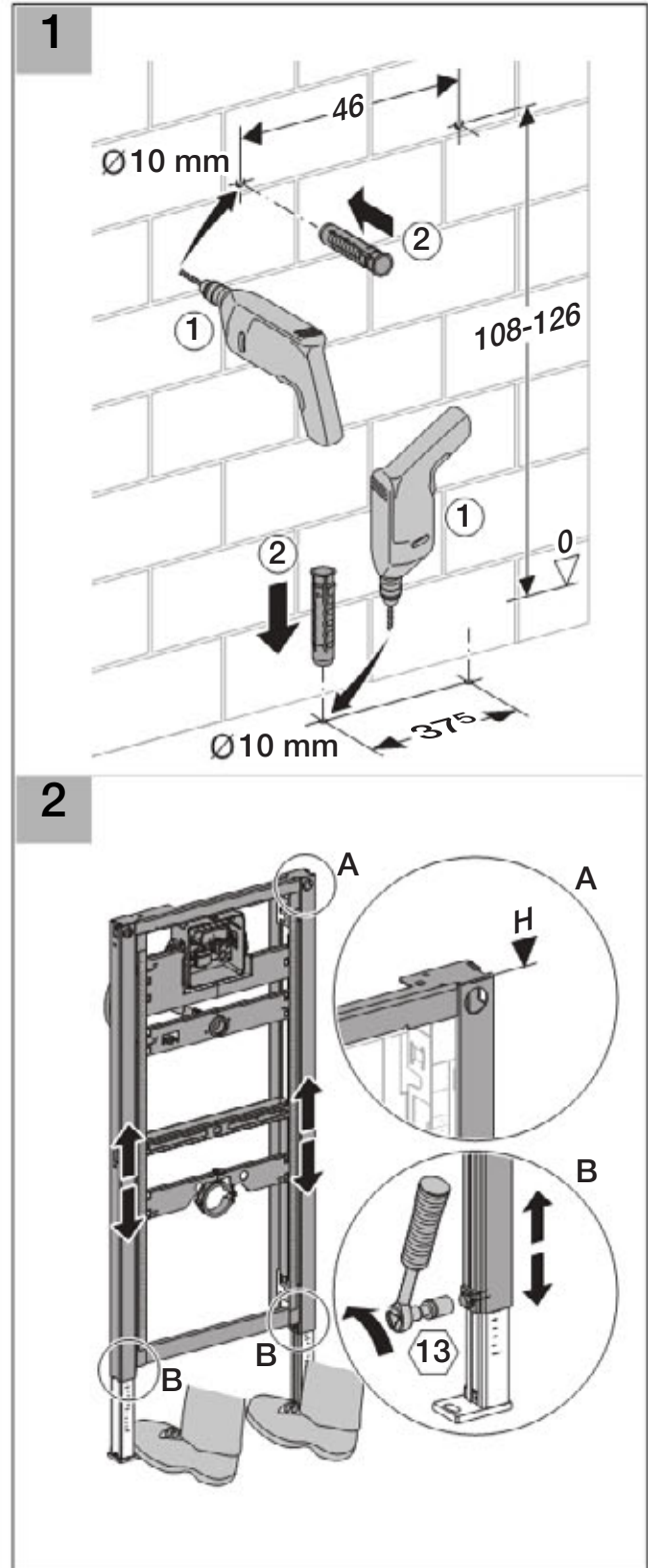
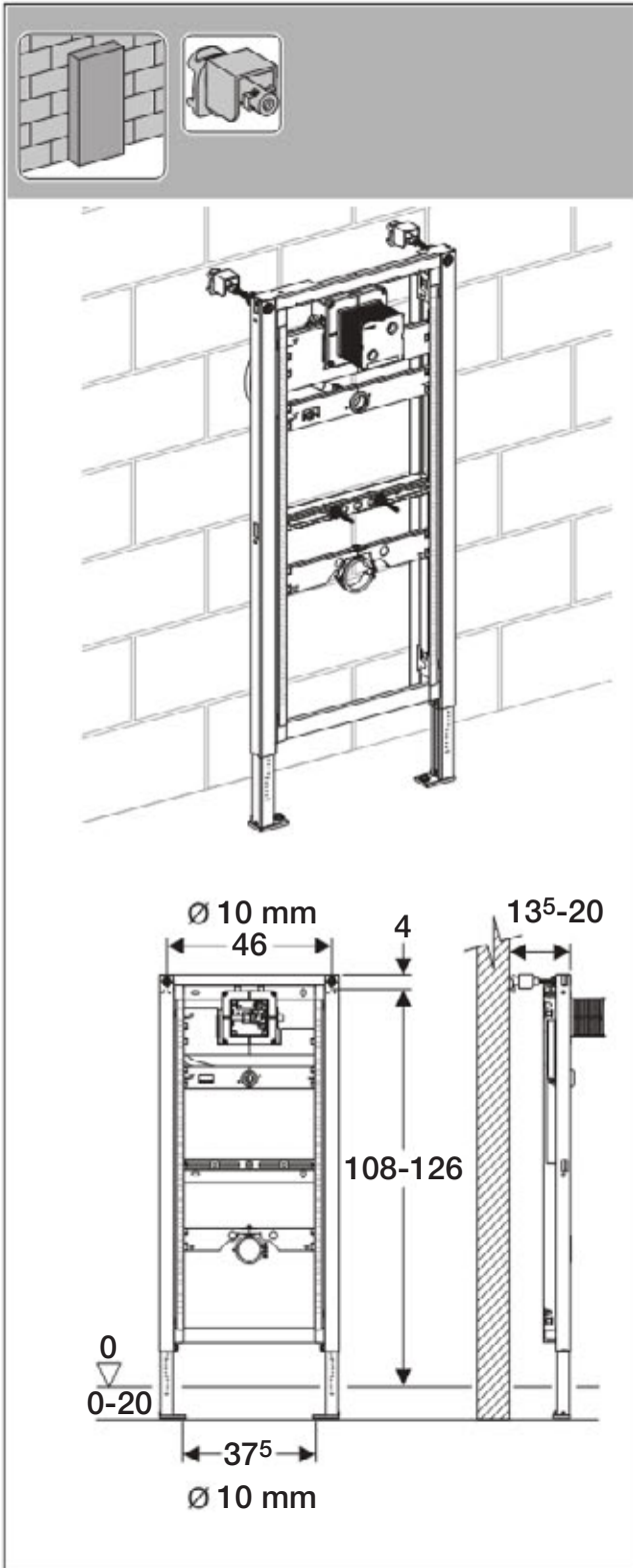

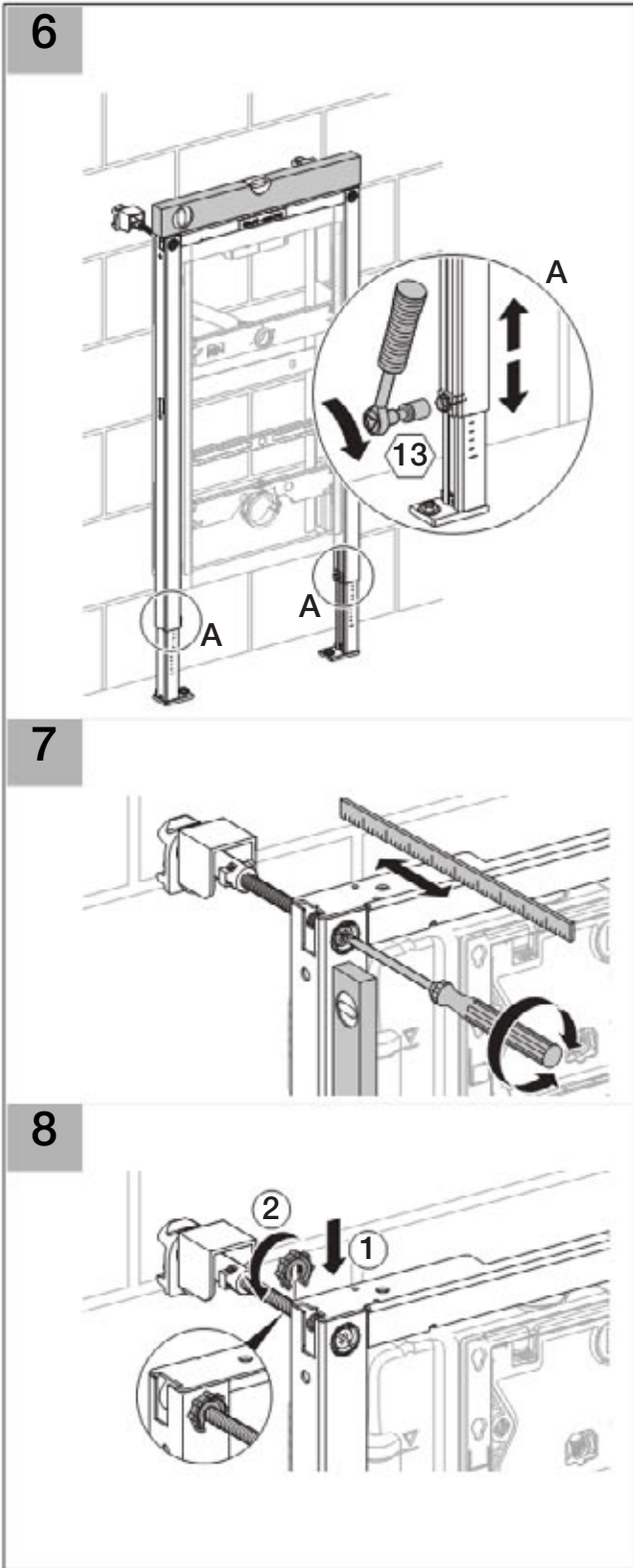
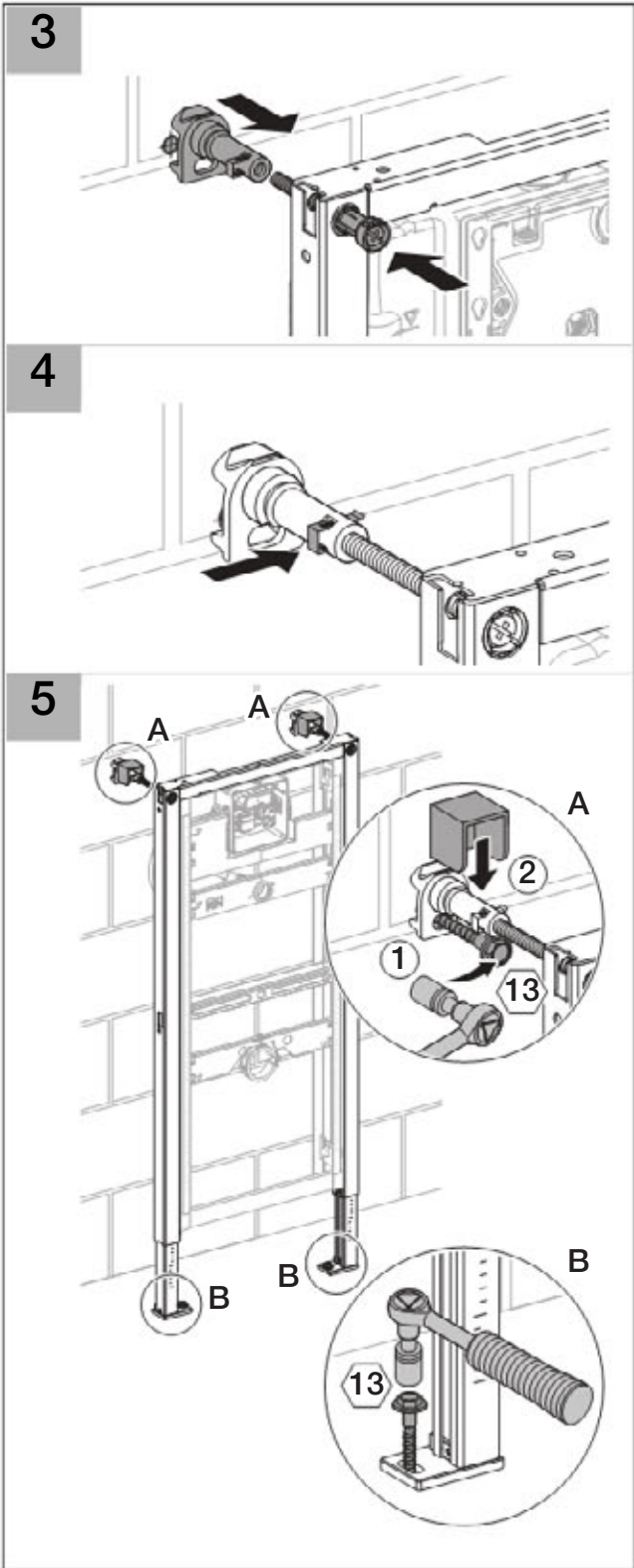

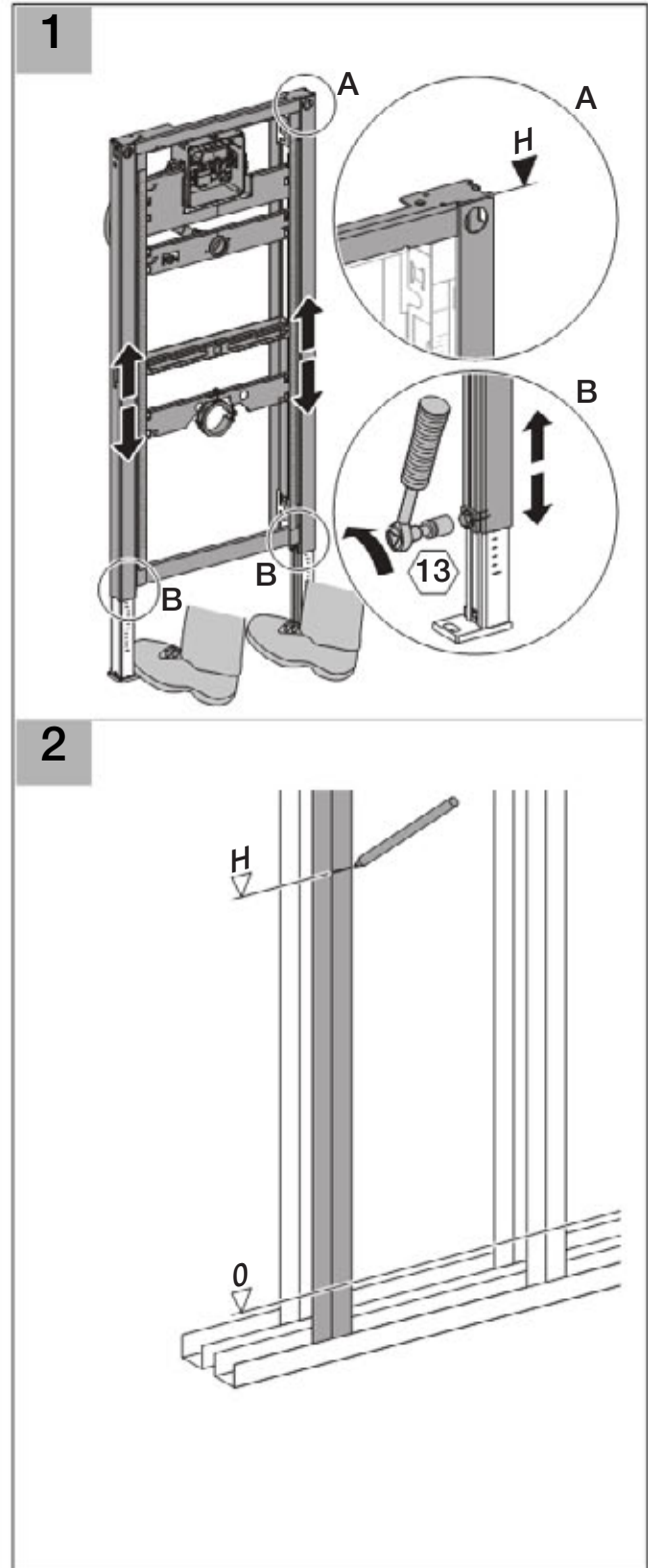
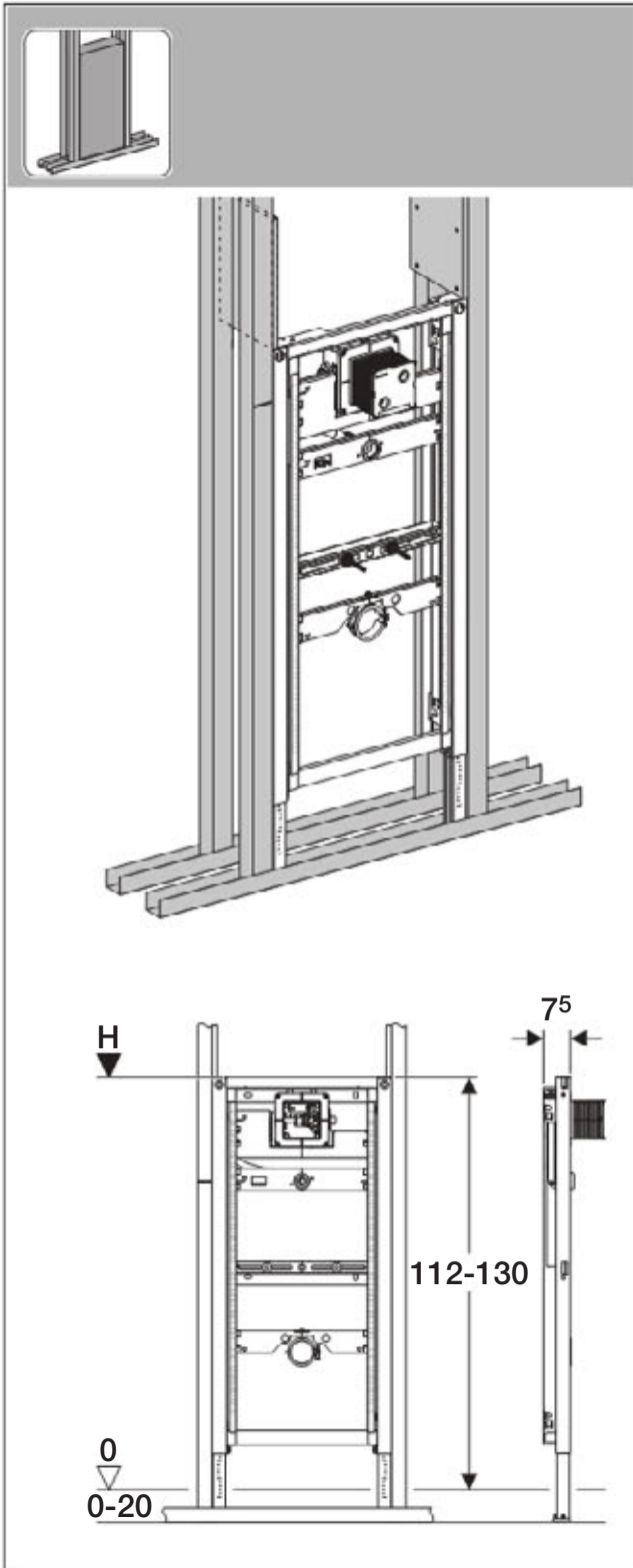

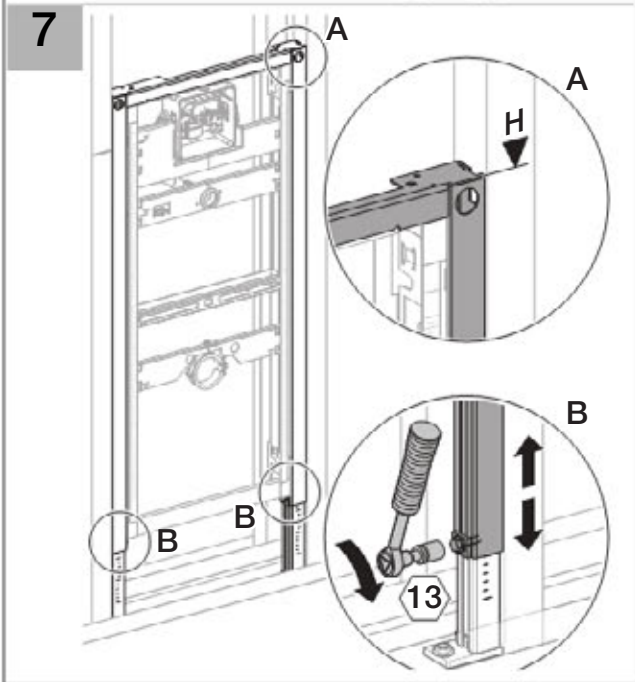
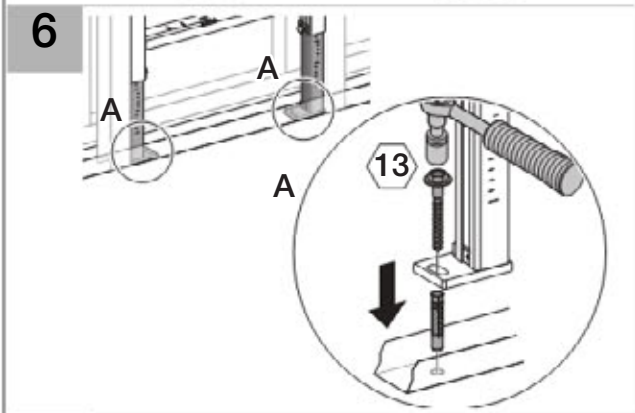
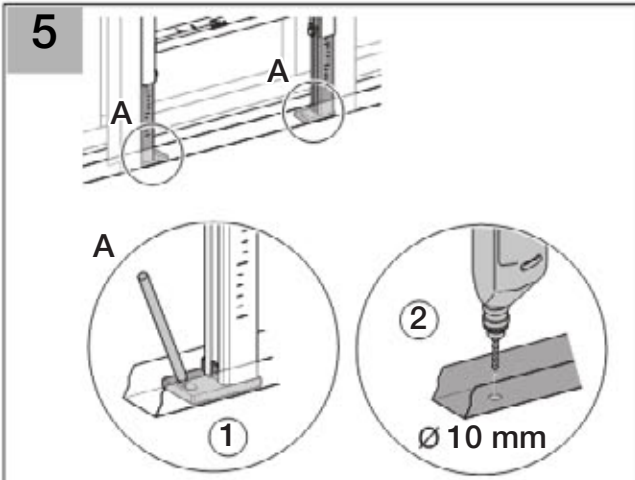
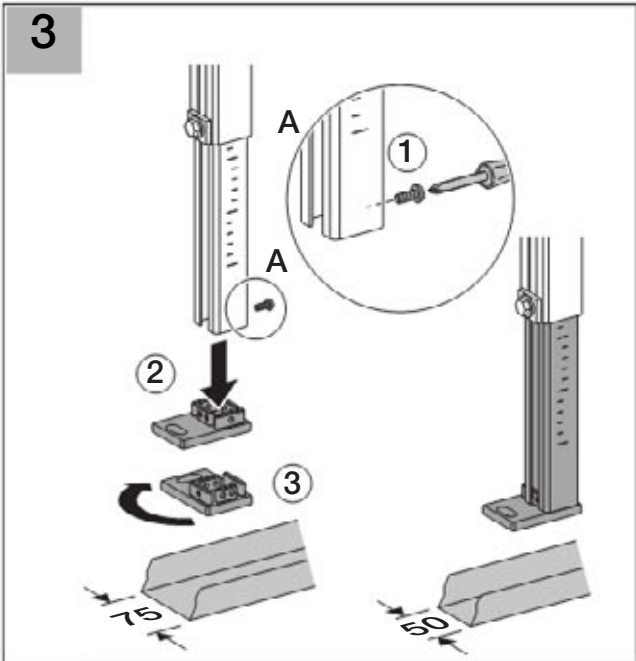

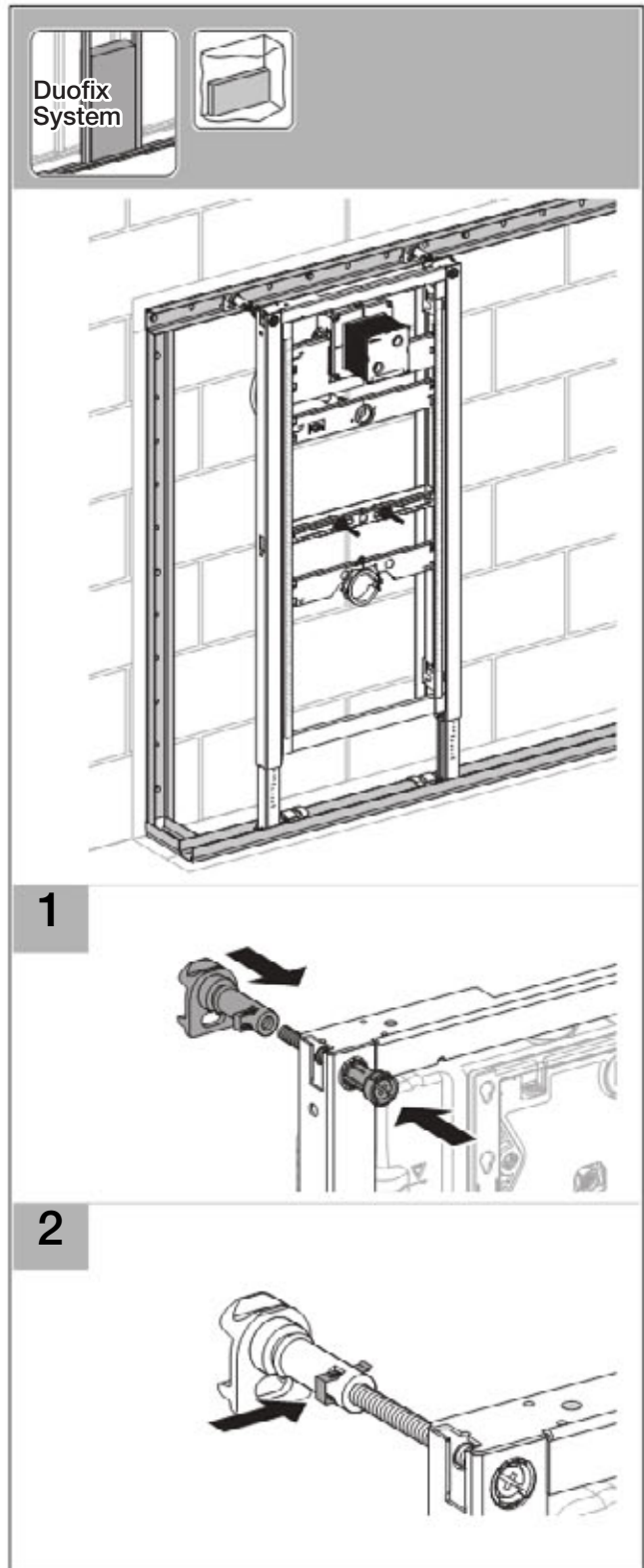
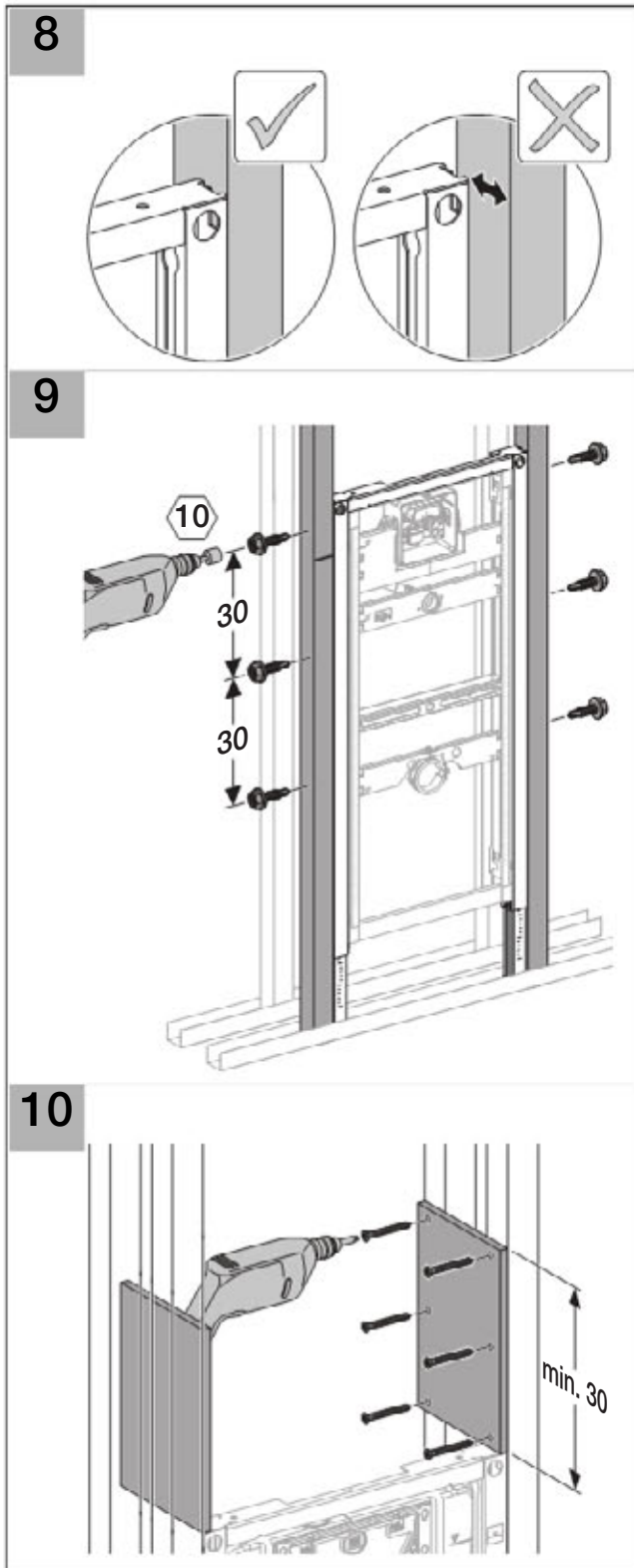

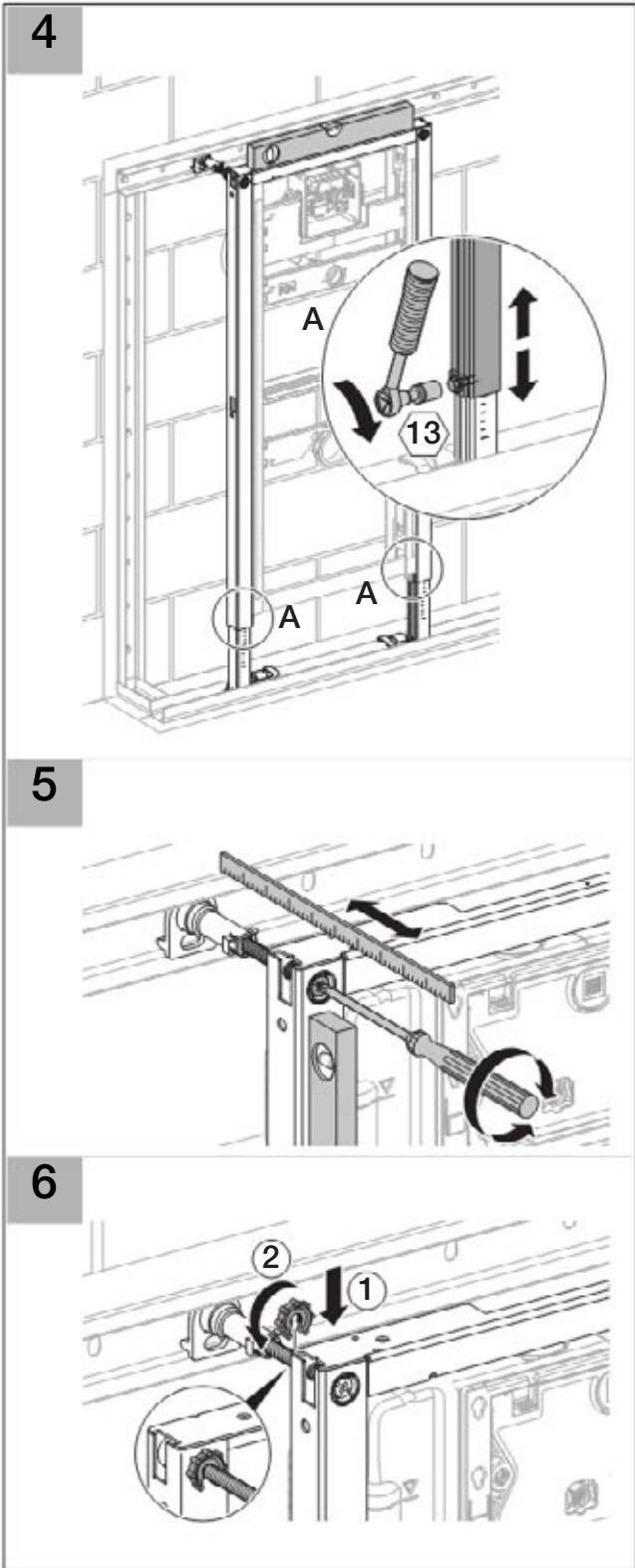
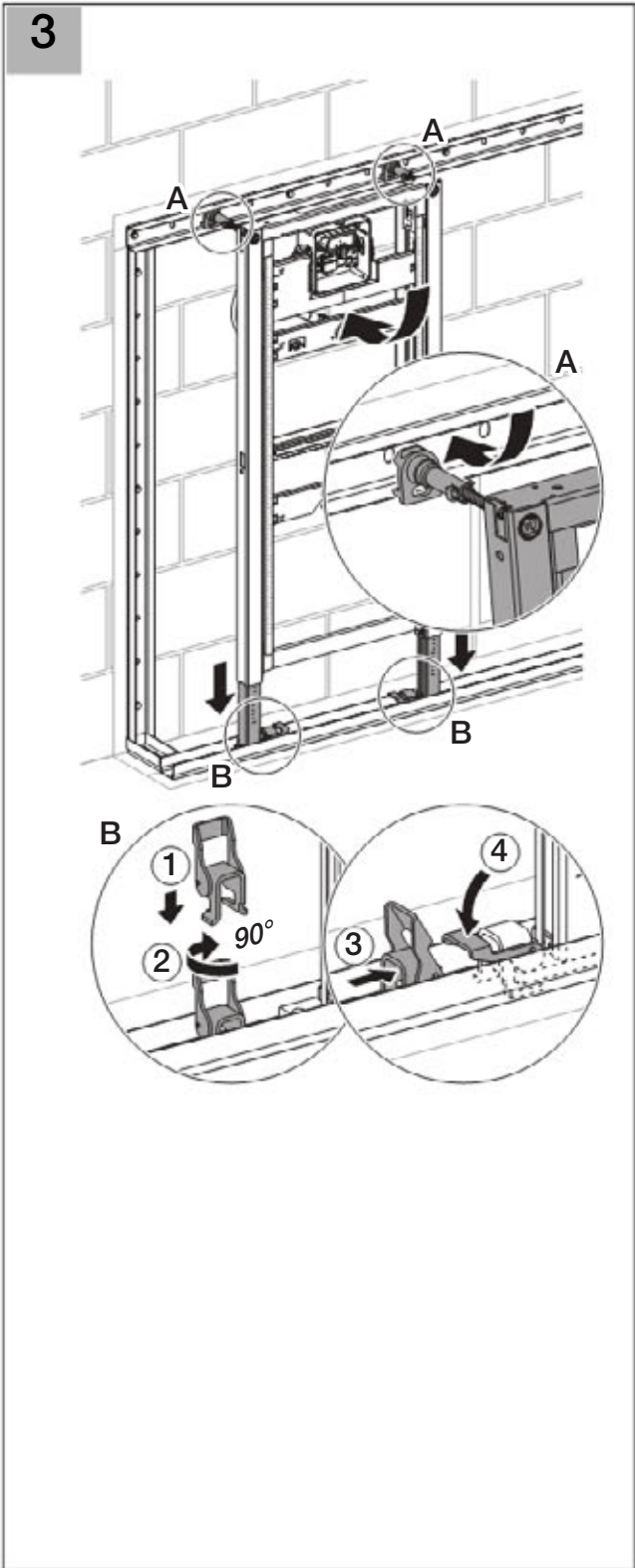

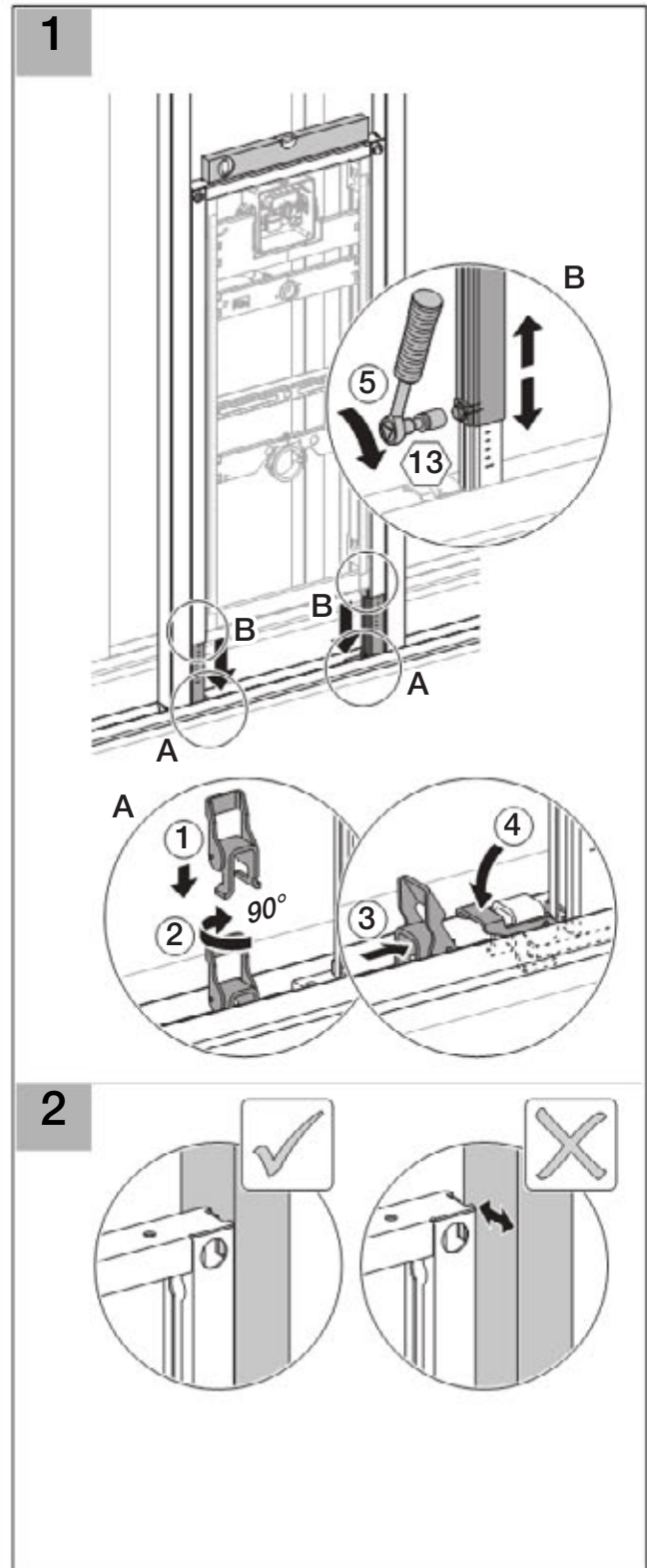
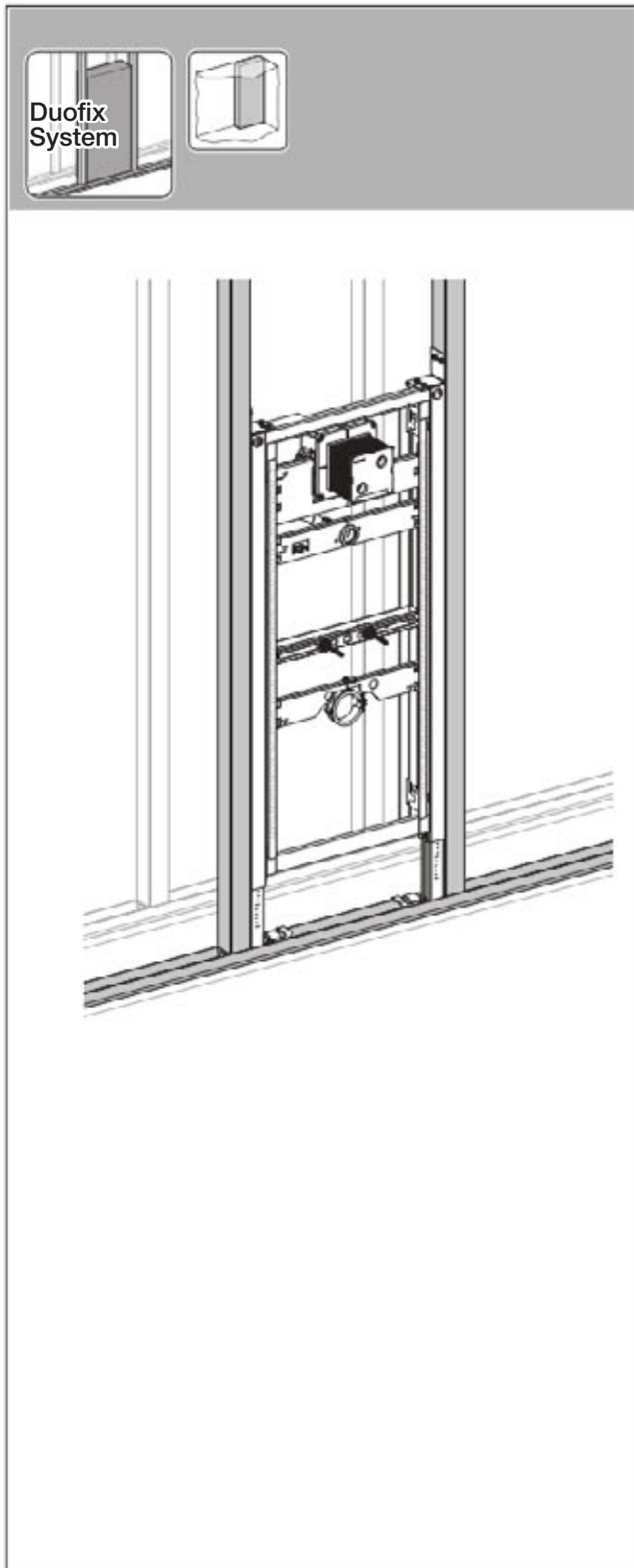

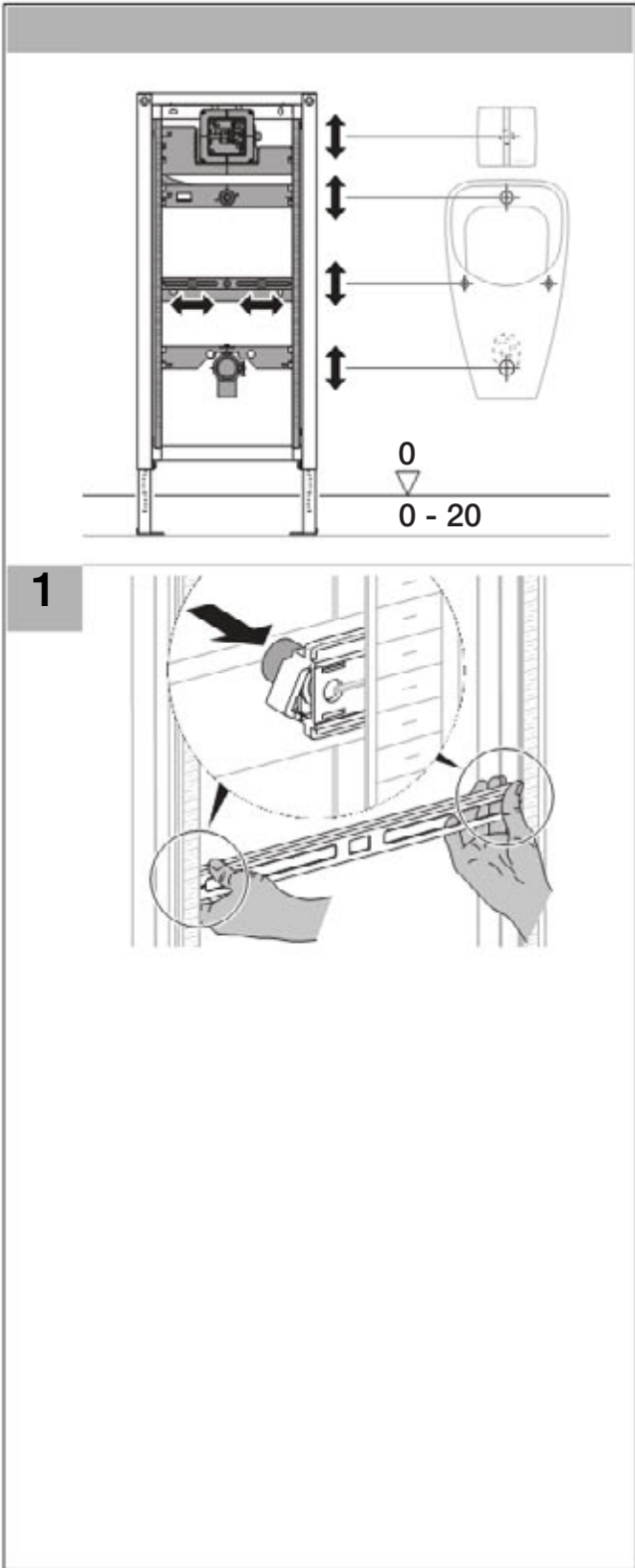
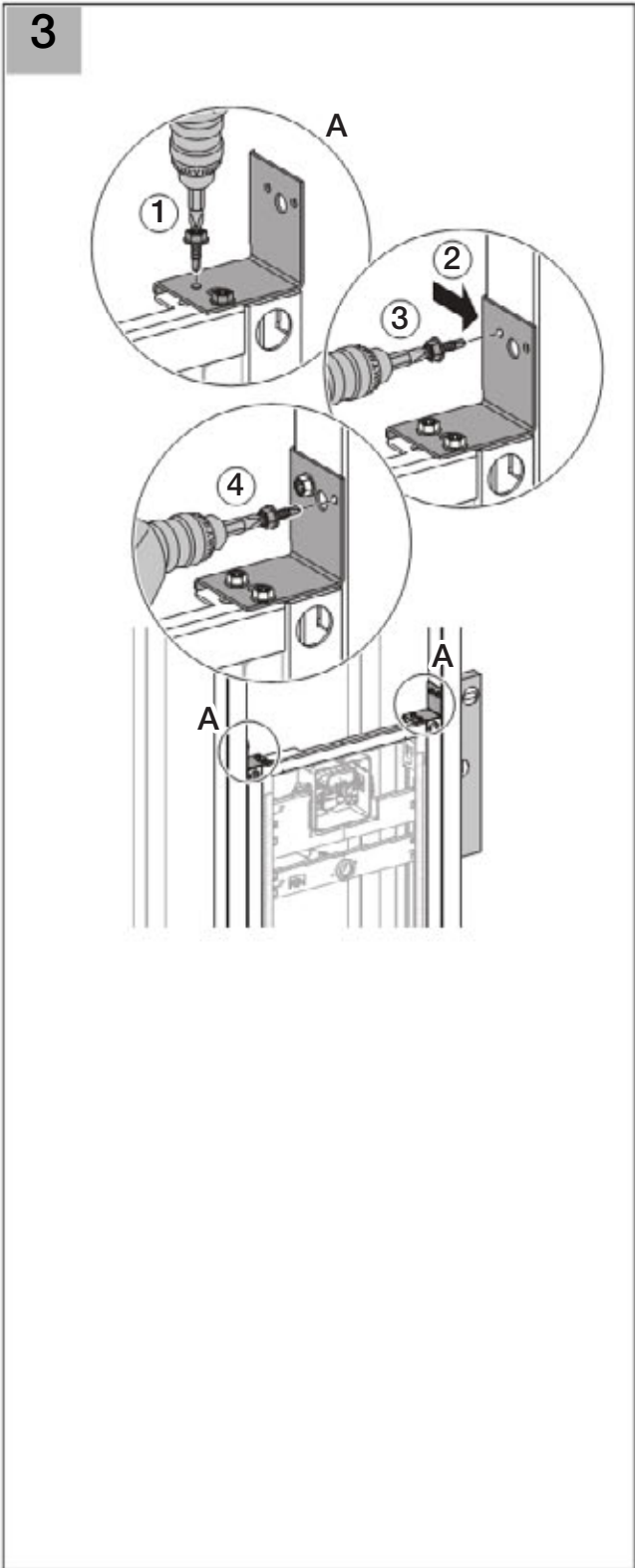

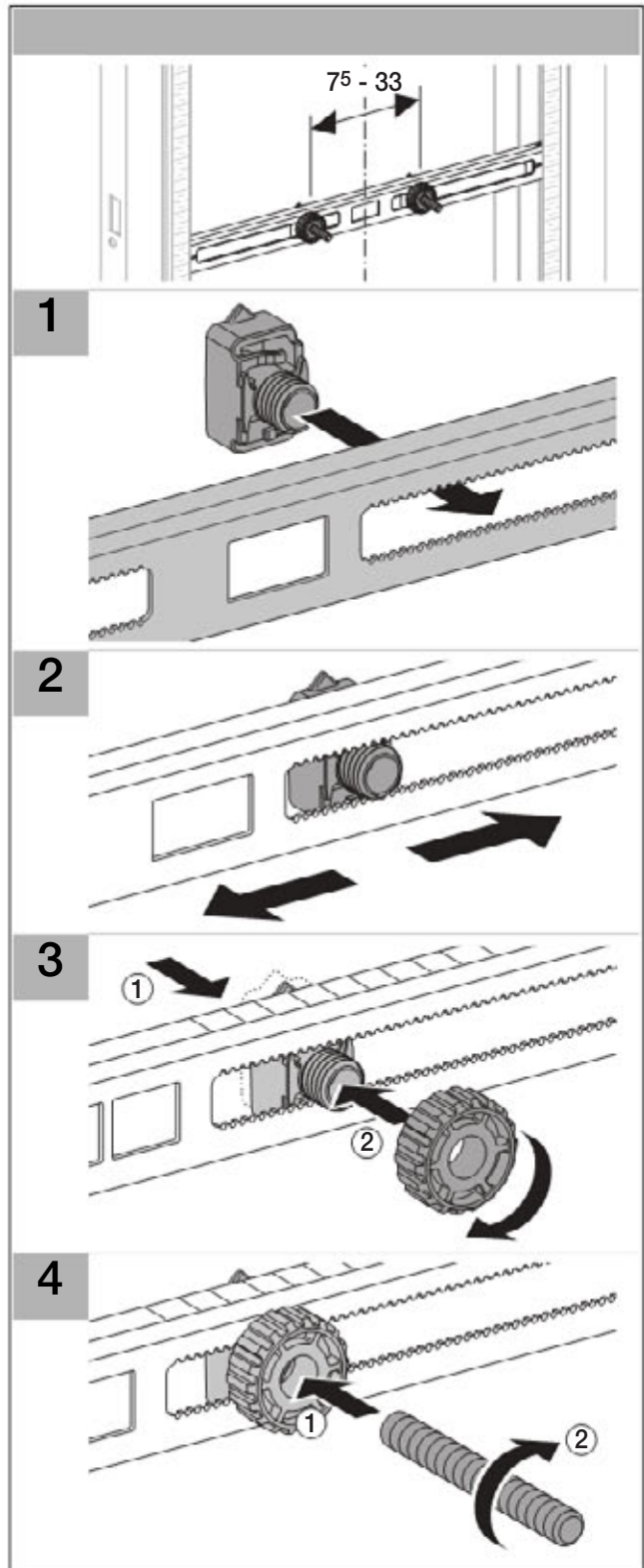
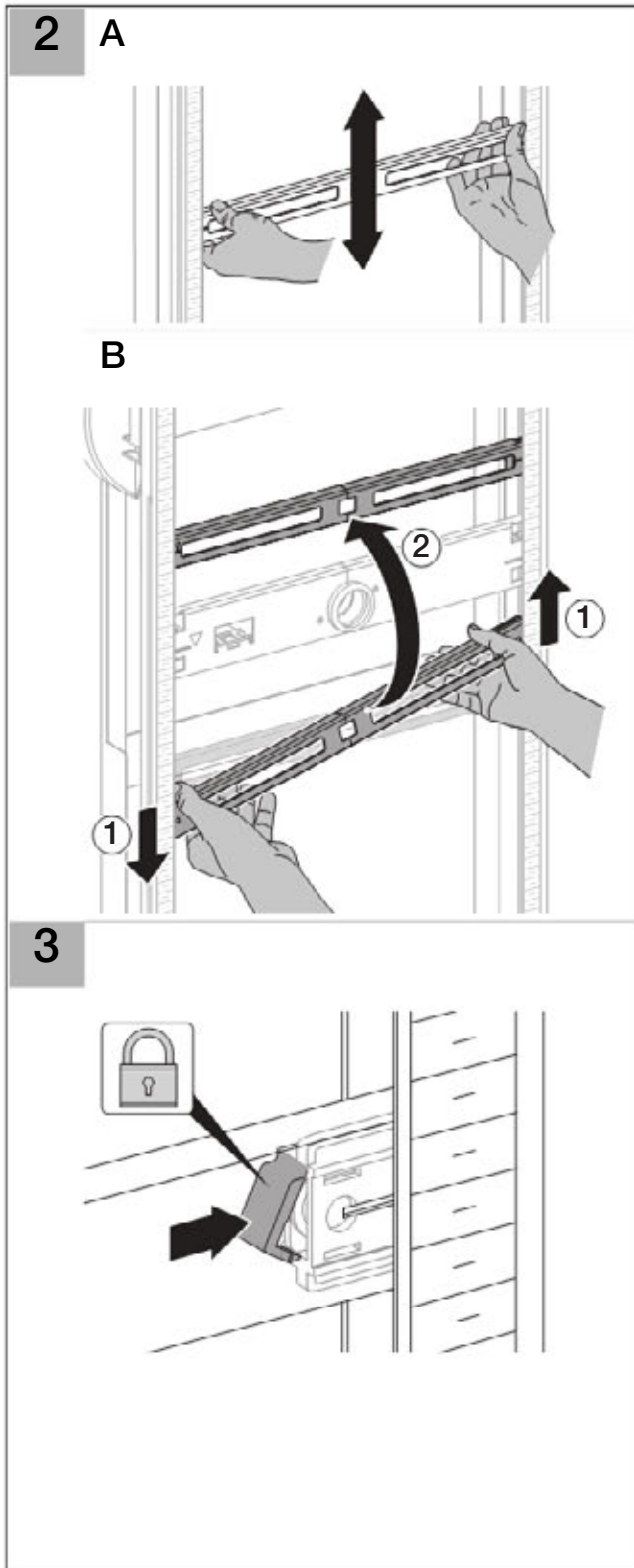

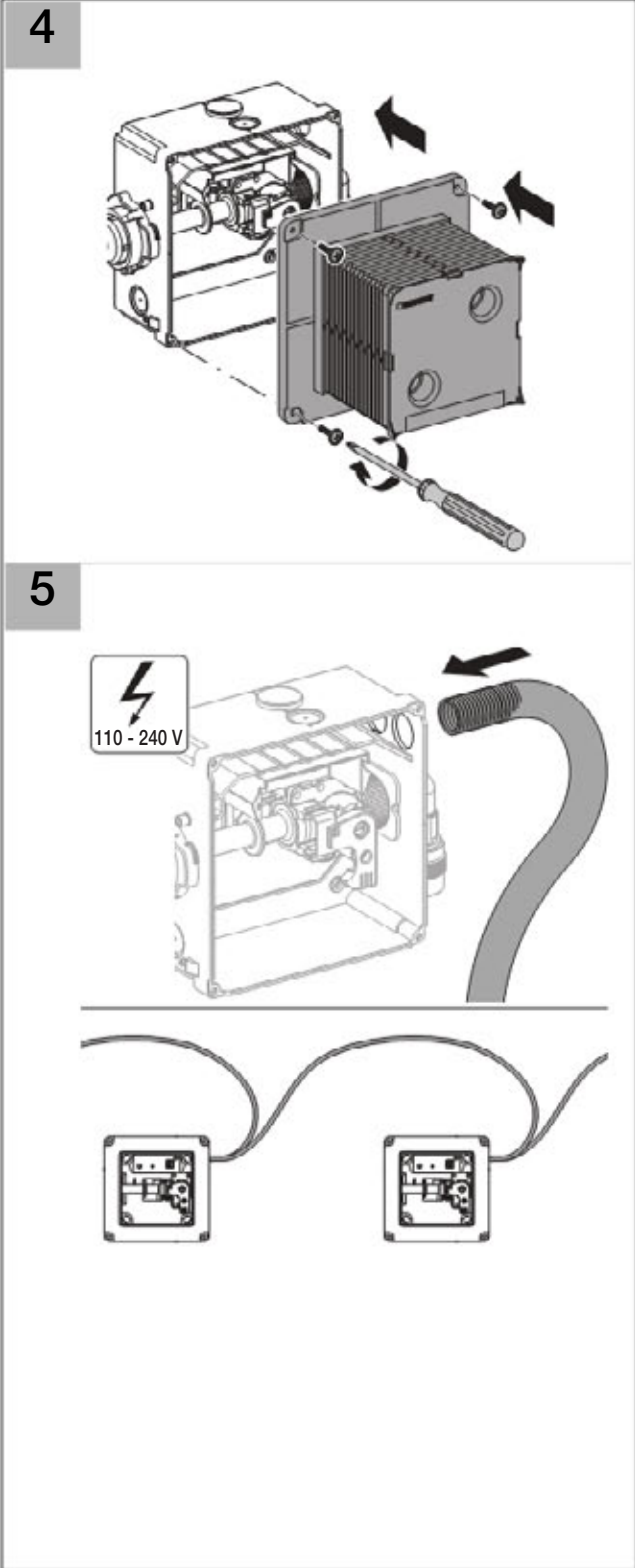
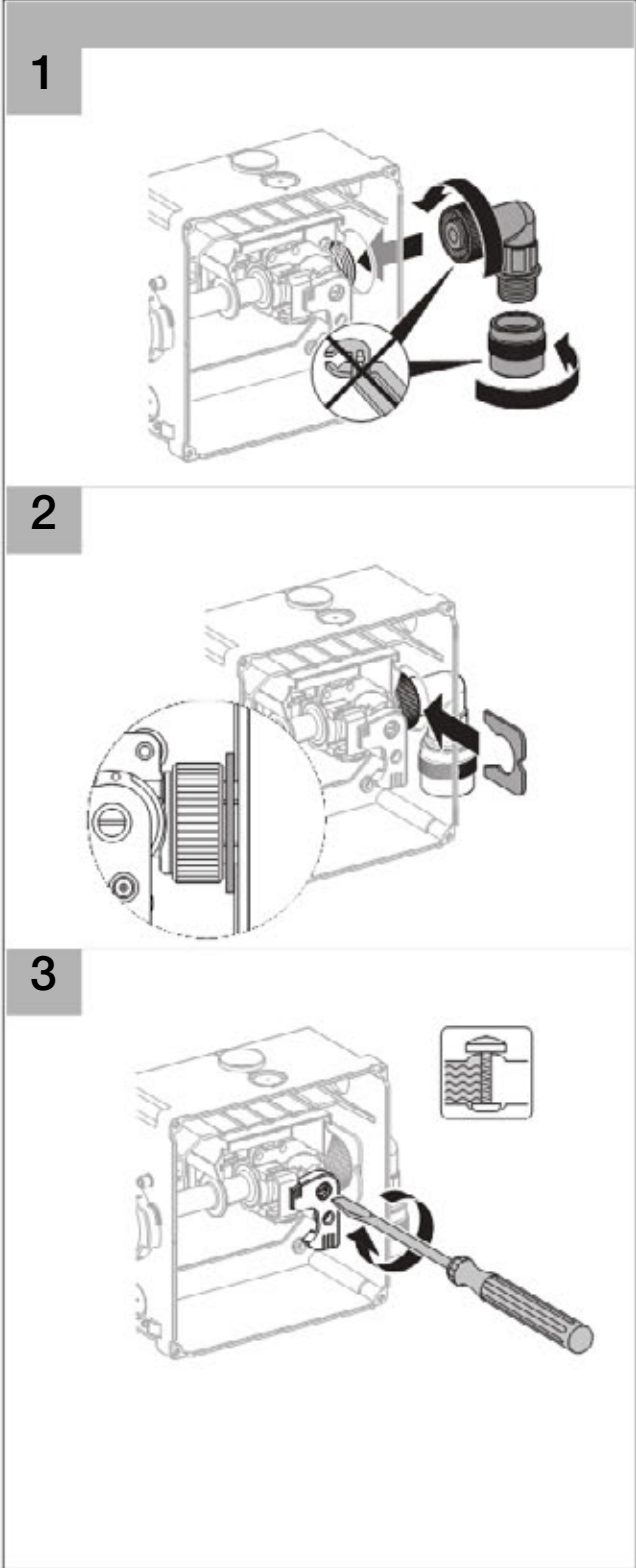

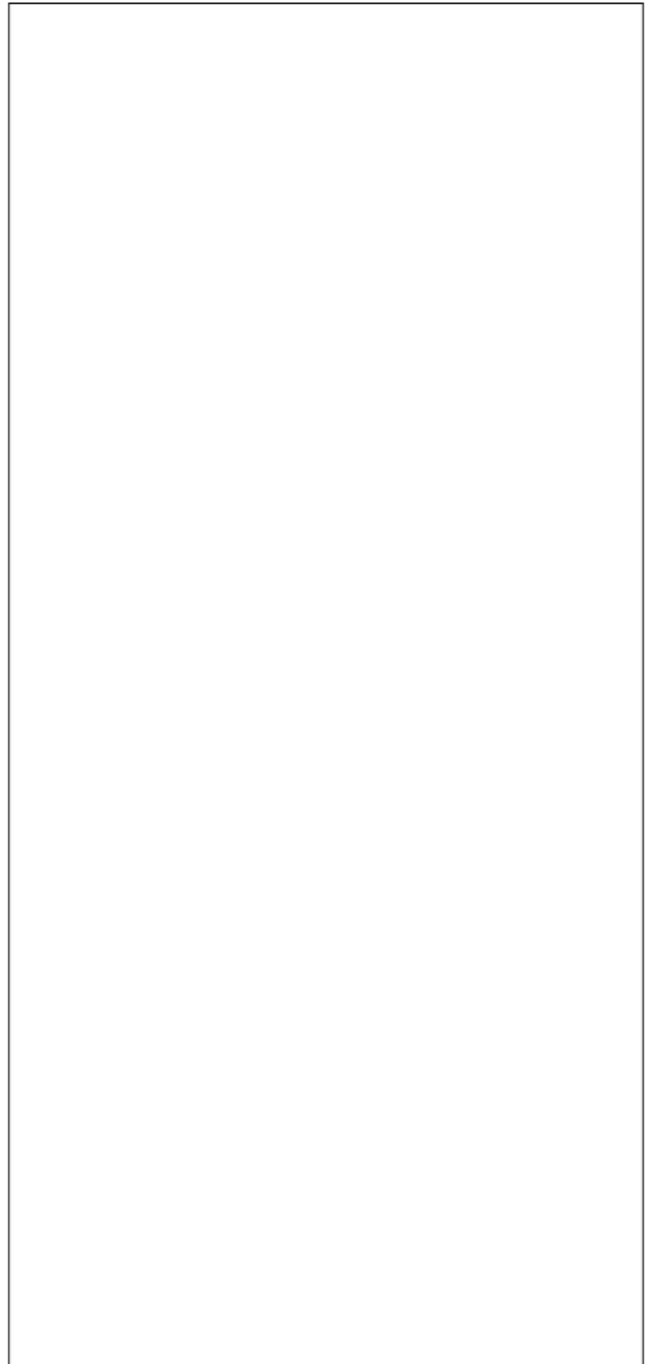
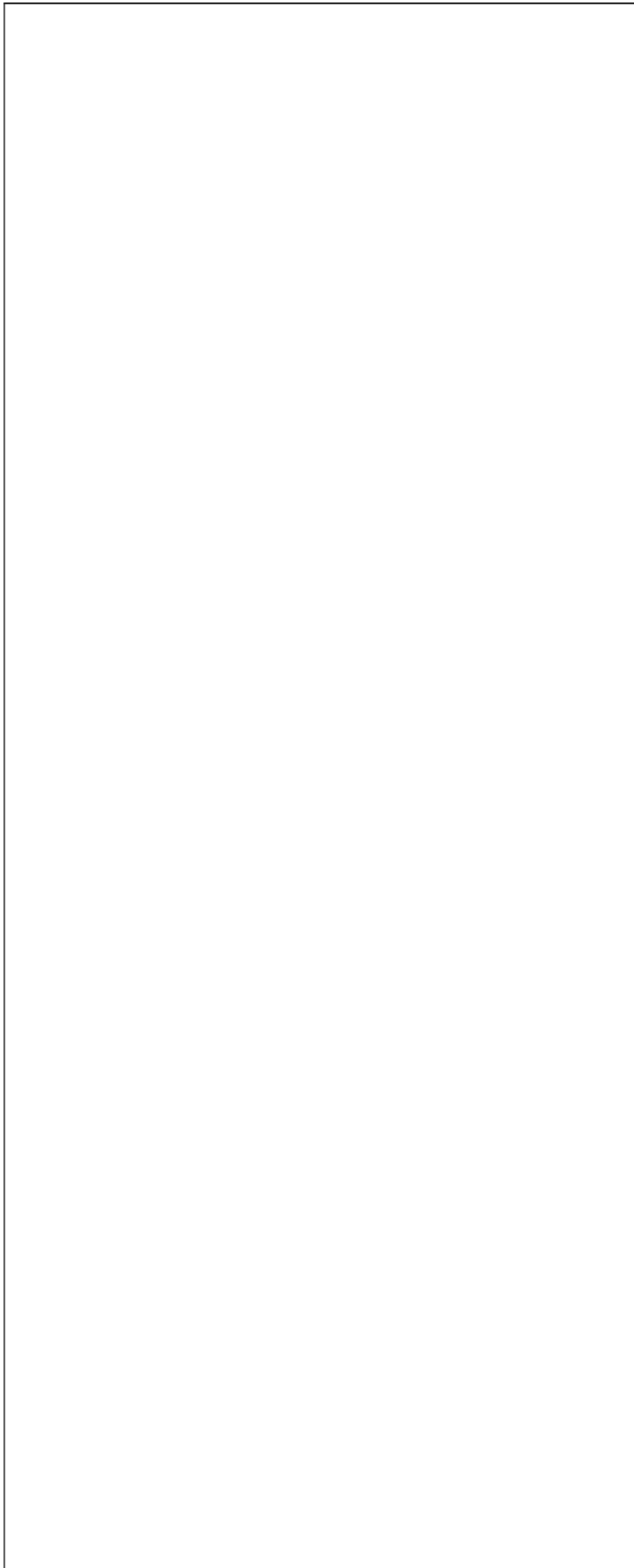

Geberit International AG
Schachenstrasse 77
CH-8645 Jona
www.geberit.com
dokumentation@geberit.com

D19932-001&BDC © 07-2008